



website:<http://biz.LGservice.com>
e-mail:<http://www.LGService.com/techsup.html>

TELEVISOR A COLORES

MANUAL DE SERVICIO

CHASIS : MC-059A

MODELO : 21FX5RG 21FX5RG-LD
21FX5RF 21FX5RF-LD

ATENCIÓN

Antes de dar servicio al chasis, lea las PRECAUCIONES DE SEGURIDAD en este manual.

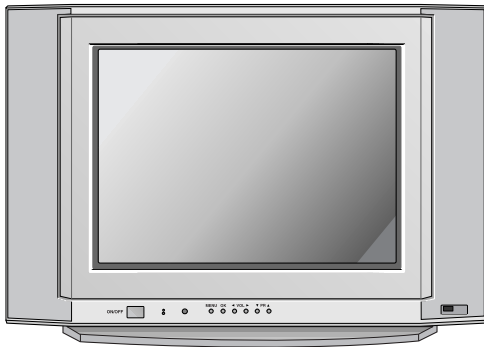

CONTENIDO

PRECAUCIONES DE SEGURIDAD.....	3
DESCRIPCION DE LOS CONTROLES	4
INSTRUCCIONES DE AJUSTE	7
VISTA EN DESPIECE	14
LISTA DE VISTA EN DESPIECE	15
LISTA DE PARTES DE REPUESTO	16
DIAGRAMA ESQUEMÁTICO	
TABLERO DE CIRCUITO IMPRESO	
GUÍA PARA UBICAR LOS COMPONENTES	
BÚSQUEDA DE FALLAS	

ESPECIFICACIONES

POTENCIA DE ENTRADA	AC100-240V~50/60Hz
CONSUMO DE ELECTRICIDAD	95W
IMPEDANCIA DE ENTRADA EN LA ANTENA	VHF/UHF: 75 Ohmios desbalanceado (solamente.)
RANGO DE LOS CANALES	
12 canales VHF	Canales 2-13
56 canales UHF	Canales 14-69
125 canales CATV	Canales 01, 02 al 13, 14 al 125
FRECUENCIAS INTERMEDIAS	
Frecuencia Intermedia portadora de la Imagen	45.75MHz
Frecuencia Intermedia portadora del Sonido	41.25MHz
Frecuencia sub-portadora del color	42.17MHz
Frecuencia del centro	44MHz
CONSTRUCCIÓN DEL CHASIS	Chasis Estado Sólido ("solid state") I.C.
TUBO DE IMAGEN.....	A51QDJ420X
.....	SALIDA DE SONIDO (a 10% de distorsión armónica) 3W+3W
GABINETE	De Madera, portátil

ABREVIACIONES UTILIZADAS EN ESTE MANUA

AC	Corriente alterna	GND	Tierra
ACC	Control automático del croma	H.V.	Alto Voltaje
ADJ	Ajuste	ITC	Centro intermedio de conmutación
AFC	Control automático de la frecuencia	OSC	Osciloscopio
AGC	Control automático de ganancia	OSD	Desplegado en pantalla ("ON SCREEN DISPLAY")
AF	Audio Frecuencia	PCB	Tablero del Circuito impreso
APC	Control automático de fase	RF	RADIO FRECUENCIA
AMP	Amplificador	SEP	Separador
CRT	Tubo de rayos catódicos	SYNC	Sincronización
DEF	Deflexión	SVC	Controles de volumen de la pantalla
DET	Detector	S.I.F.	Frecuencia intermedia de sonido
DY	Yugo deflector ("deflection yoke")	V.I.F.	Frecuencia intermedia del video
ES	Electrostáticamente sensible	H	Horizontal
FBP	Pulso de retorno	V	Vertical
FBT	Transformador de retorno	IC	Circuito integrado

PRECAUCIONES DE SEGURIDAD

ADVERTENCIA: Antes de dar servicio a este chasis, lea "PRECAUCIONES RESPECTO A RADIACION POR RAYOS X", "INSTRUCCIONES DE SEGURIDAD" y "AVISO SOBRE SEGURIDAD DE PRODUCTOS"

PRECAUCIONES RESPECTO A RADIACION POR RAYOS "X"

1. El voltaje excesivo puede causar RADIACIÓN POR RAYOS "X" potencialmente peligrosa. Para evitar tales peligros, el voltaje no debe exceder el límite especificado. El valor nominal para el alto voltaje de este receptor es de 25KV en brillantez máxima bajo la fuente especificada. El alto voltaje no deberá exceder, bajo ninguna circunstancia, de 28KV. Cada vez que el receptor requiera servicio, se debe verificar el alto voltaje y registrarlo como parte del historial de servicio del aparato.
Es importante utilizar un medidor de voltaje que sea preciso y confiable.
2. La única fuente de RADIACION DE RAYOS-X en este receptor de televisión es el tubo de la imagen. Para protección continuada de la RADIACION DE RAYOS-X, el reemplazo que se haga del tubo debe ser con otro del mismo tipo especificado en la lista de partes.
3. Algunas partes de este receptor tienen características especiales relacionadas con la protección contra RADIACION DE RAYOS-X. Para que la protección sea continua, la selección de partes de repuesto se debe hacer solo después de haberse referido al AVISO SOBRE SEGURIDAD DE PRODUCTOS que aparece mas abajo.

INSTRUCCIONES DE SEGURIDAD

1. Cuando el receptor está en operación, se producen voltajes potencialmente tan altos como 25,000-29,000 voltios. Operar el receptor fuera de su gabinete o con la tapa trasera removida puede causar peligro de choque eléctrico.
 - (1) Nadie debe intentar dar servicio si no está debidamente familiarizado con las precauciones que son necesarias cuando se trabaja con un equipo de alto voltaje.
 - (2) Siempre descargue el ánodo del tubo de la imagen a tierra para evitar el riesgo de choque eléctrico antes de remover la tapa del ánodo.
 - (3) Descargue completamente el alto potencial del tubo de imagen antes de manipularlo. El tubo de la imagen es de alto vacío y, si se rompe, los fragmentos de vidrio salen despedidos violentamente.
2. Si se quemara algún fusible de este receptor de televisión, reemplácelo con otro especificado en la lista de partes.
3. Cuando reemplace tableros o plaquetas de circuitos, cuidadosamente enrolle sus alambres alrededor de las terminales antes de soldar.
4. Cuando reemplace un resistencia de vataje (resistor de película de óxido metálico) en el Tablero o Plaqueta de circuitos, mantenga la resistencia a un mínimo de 10mm de distancia.
5. Mantenga los alambres lejos de componentes de alto voltaje o de alta temperatura.
6. Este receptor de televisión debe conectarse a una fuente de 100 a 240 V AC.
7. Antes de devolver este aparato al cliente, haga una verificación de fuga de corriente sobre las partes metálicas del gabinete expuestas, tales como antenas, terminales, cabezas de tornillos, tapas de metal, palancas de control etc., para estar seguro de que el equipo funciona sin peligro de choque eléctrico. Enchufe el cordón directamente al tomacorriente de la línea de AC 100-240V.

No utilice una línea aislada de transformador durante esta verificación. Use un voltímetro de 1000 Ohmios por voltio de sensibilidad o más, en la forma que se describe a continuación.

Cuando la unidad está ya conectada a la AC, pulse el conmutador primero poniéndolo en "ON" (encendiendo) y luego en "OFF" (apagando), mida desde un punto de tierra conocido, tal como una (cañería de metal, una manija metálica, una tubería etc.) a todas las partes metálicas expuestas del receptor de televisión (antenas, manijas de metal, gabinetes de metal, cubiertas de metal, palancas de control etc..) especialmente cualquiera de las partes metálicas expuestas que puedan ofrecer un camino hacia el chasis. Ninguna medición de corriente eléctrica debe exceder de 0.5 miliamperios. Repita la prueba cambiando la posición del enchufe en el tomacorriente. Cualquier medición que no esté dentro de los límites especificados aquí representan un riesgo potencial de choque eléctrico que debe ser eliminado antes de devolver el equipo al cliente.

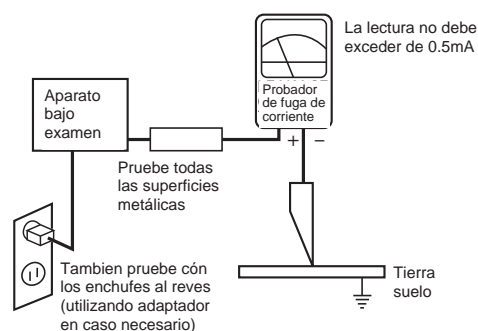

AVISO SOBRE SEGURIDAD DE PRODUCTOS

Muchas de las partes, eléctricas y mecánicas en este chasis tienen características relacionadas con la seguridad. Estas características frecuentemente pasan desapercibidas en las inspecciones visuales y la protección que proporcionan contra la RADIACION DE RAYOS-X no siempre necesariamente se obtiene al mismo grado cuando se reemplazan piezas o componentes diseñados para voltajes o vatajes mayores, etc. Las piezas que tienen estas características de seguridad se identifican por la marca Δ impresa sobre el diagrama esquemático y la marca \square impresa en la lista de partes. Antes de reemplazar alguno de esos componente, lea cuidadosamente la lista de este manual. El uso de partes de reemplazo que no tengan las mismas características de seguridad, como se especifica en la lista de partes, puede crear Radiacion de Rayos-X.

DESCRIPCION DE LOS CONTROLES

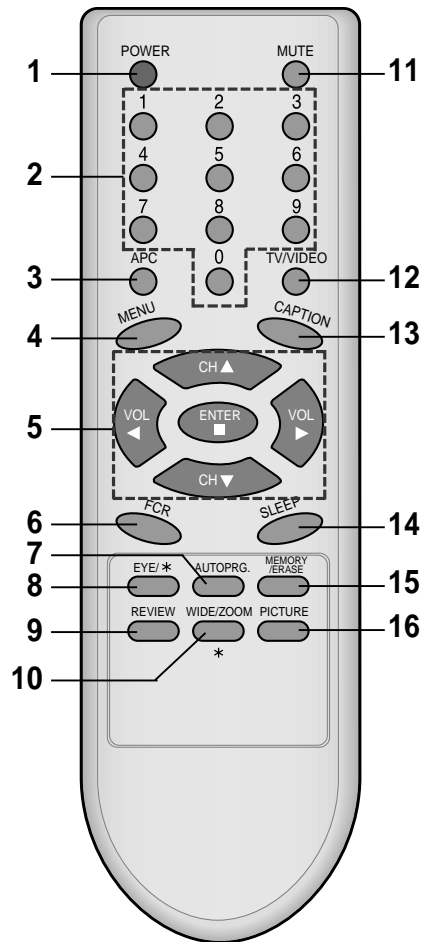

1. **BOTON ENCENDIDO (o ON/OFF)**
Refierase al "Encendido / Apagado del TV".
2. **BOTONES NUMERADOS**
Para seleccionar directamente el canal deseado.
3. **BOTON APC (Control Automático de la Imagen)**
Para ajustar la imagen establecida por la fábrica.
4. **BOTON MENU**
Para exhibir en la pantalla los menús.
5. **BOTONES CH (▲/▼)**
 - Para seleccionar el canal deseado.
 - Para seleccionar el ítem del menú deseado cuando el menú está exhibido en la pantalla.
- BOTONES VOLUMEN (◀/▶)**
 - Para incrementar o disminuir el nivel del volumen.
 - Para entrar o ajustar el menú seleccionado cuando el menú está exhibido en la pantalla.
- BOTON ENTER (■)**
 - Para salir del Menú exhibido.
 - Para memorizar el Menú ajustado.
 - Para volver al modo de TV. (Solamente por control remoto)
6. **BOTON FCR (Revisión de Canal Favorito)**
Para seleccionar sus canales favoritos.
Refierase a "Memoria de canales favoritos".
7. **BOTON AUTO PRG. (Auto program)**
Para memorizar los canales por medio de la autoprogramación.
8. **BOTON EYE/* (Algunos modelos)**
Para activar o desactivar la función de Ojo Mágico.
* : No funciona.
9. **BOTON REVIEW (Algunos modelos)**
Para retornar al canal anterior.
10. **BOTON WIDE/ZOOM/* (Algunos modelos)**
Para seleccionar el formato de imagen deseado. (4:3, 16:9 or ZOOM).
* : No funciona.
11. **BOTON MUTE**
Para pausar el sonido.
Presione nuevamente para restablecer el sonido.

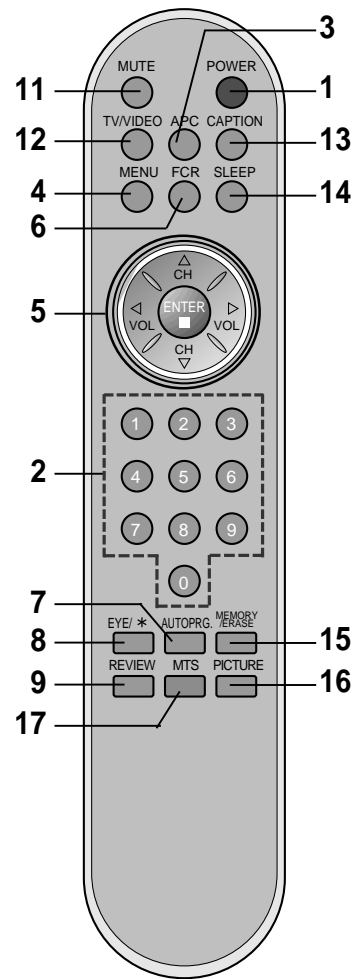
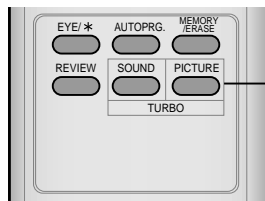
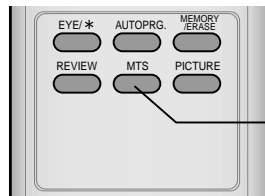
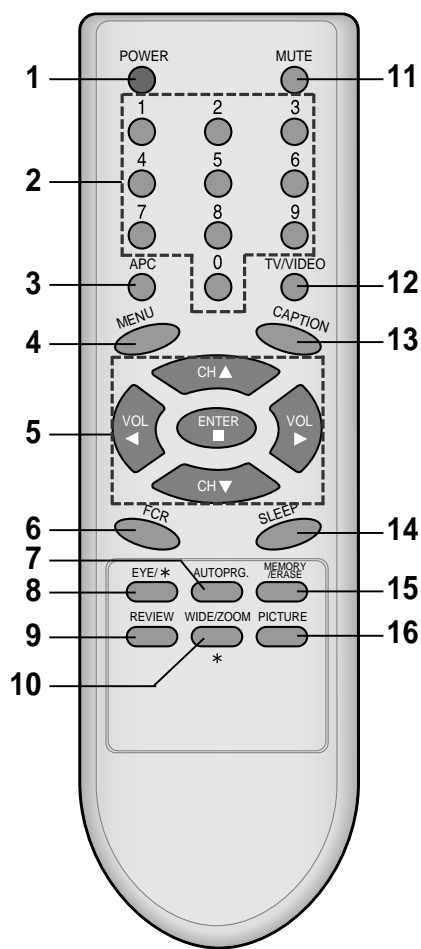

12. BOTON TV/VIDEO (Algunos modelos)

Para seleccionar el modo TV, VIDEO o COMPONENT.

13. BOTON CAPTION (Algunos modelos)

Para seleccionar el modo de Subtítulos. Refiera a la "Función de Subtitulaje".

BOTON SLEEP

Para fijar el tiempo de apagado, si desea dormir.

15. BOTON MEMORY/ERASE (Algunos modelos)

Para memorizar o borrar el canal deseado.

16. BOTON PICTURE (Algunos modelos)

Para exhibir los modos de imagen uno por uno.

17. BOTON MTS (Algunos modelos)

Para escuchar sonido MTS.

18. BOTON TURBO SOUND/TURBO-S

(Algunos modelos)

Para seleccionar Turbosonido.

BOTON TURBO PICTURE/TURBO-P

(Algunos modelos)

Para seleccionar Turboimagen.

DESCRIPCION DE LOS CONTROLES

Esta es una presentación simplificada del panel frontal.

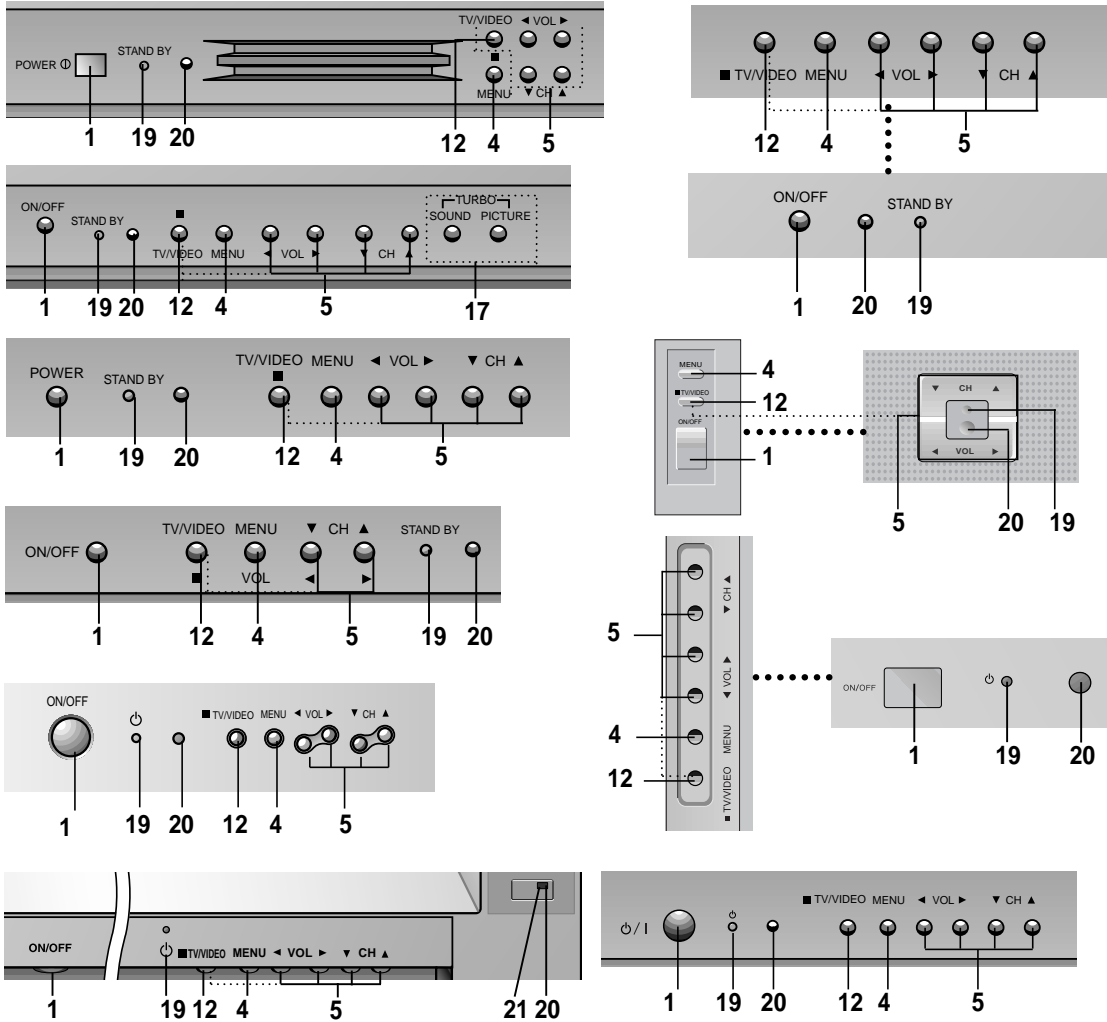

19. INDICADOR MODO DE ESPERA (STAND BY \circ ⏻)

Se ilumina en color rojo cuando el televisor esta en modo de espera. Refierase al "Encendido / Apagado del TV".

20. SENSOR DEL CONTROL REMOTO

INSTRUCCIONES DE AJUSTE

1. Objeto de aplicación

Estas instrucciones se aplican al chasis MC-059A.

2. Notas

- (1) Debido a que este no es un chasis caliente, no es necesario utilizar un transformador de aislamiento. De todas formas, el uso de un transformador de aislamiento ayudará a proteger los instrumentos de prueba.
- (2) Los ajustes deben ser realizados en el orden correcto.
- (3) Los ajustes deben ser efectuados bajo condiciones de $25\pm 5^{\circ}\text{C}$ de temperatura y $65\pm 10\%$ de humedad relativa si no se especifica alguna designación.
- (4) El voltaje de entrada del receptor debe mantenerse en $(100\sim 240\text{V})\pm 10\%$, 50/60Hz durante el ajuste.
- (5) El receptor debe ponerse en funcionamiento al rededor de 15 minutos antes del ajuste. Pero el ajuste en el tablero puede hacerse en el estado jig inmediatamente.
- (6) Señal : la señal de color estandar esta aprobada en $65\pm 1\text{dB}\mu\text{V}$. La señal estandar de color se refiere a la señal de patron digital.

3. Ajuste del Voltaje AGC

3.1 Equipos de medición

Multimetro Digital : 1EA

- Corriente max entrada: Sobre 1A/Voltaje max de entrada: 500Vdc
- Rango de medida: 10mV-100mVdc/Exactitud: 0.03%

3.2 Pasos preliminares

- (1) Inyectar un patron digital de 65dB($\pm 1\text{dB}$) a la terminal de la antena de 75Ω .
- (2) Conectar el multimetro digital a la terminal(J105/con agujero) Marcado "AGC CHECK" en la tarjeta. Para revisar AGC.

3.3 Ajuste

- (1) Seleccionar el modo de ajuste VP 0(RF AGC) presionando el boton IN-START en el control remoto de servicio.
- (2) Después de seleccionar RF AGC usando el boton CH +/- ($\blacktriangle/\blacktriangledown$) ajustar el voltaje hasta $2.3\pm 0.05\text{V}$ usando VOL +/- ($\blacktriangleleft/\blacktriangleright$).
- (3) **PRECAUCIÓN** : Ya que la intensidad de la señal puede ser fácilmente cambiada por la condición del cable de señal, necesita verificar frecuentemente la intensidad de la señal para prevenir desajustes.

4. Voltaje de Pantalla

4.1 Ajuste Manual de la Pantalla

(Utilizando ADJ (AJUSTE) del Control Remoto)

- (1) Reciba la señal NTSC en el modo RF sin considerar el canal.
- (2) Si presiona el botón "ADJ" en el modo LINE SVC (botón IN-START), el modo LINE SVC cambia al modo de ajuste de la pantalla.

- (3) Ajuste el SCREEN VOL. del FBT para que aparezca la Línea Horizontal y ajuste el SCREEN VOL. del FBT en el punto donde desaparece la Línea Horizontal. (Presione el botón Enter(■) para salir del modo SVC)

5. Ajuste de Pureza y Convergencia

5.1 Ajuste de Pureza

(1) Pasos preliminares

1. Reciba el patrón de barrido ROJO.
2. Desmagnetize el CPT y el gabinete con un desmagnetizador.

(2) Ajuste de Línea Horizontal

1. Preajuste la Convergencia estática(STC) con el magneto de 4 y 6 polos.
2. Verifique si el haz cae en el agujero de la malla fijando dos magnetos bipolares en direcciones opuestas respectivamente.
3. Si no, ajuste un magneto bipolar de manera que el haz caiga en el agujero de la malla con precisión.

(3) Ajuste de Pureza

1. Acerque el Yugo al CPT.
2. Reciba el patrón rojo y ajuste el magneto de dos polos barras de color rojo para localizar el centro y hacer las porciones de color verde y azul iguales.<Fig. 1> (Tenga cuidado con el ARO si el magneto de dos polos está abierto más de 30 grados)

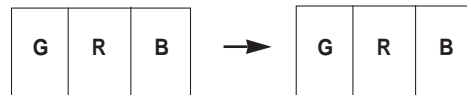

<Fig. 1>

3. Ponga la pantalla completamente roja, moviendo el Yugo hacia atrás lentamente.<Fig. 2> (Cuando ajuste el yugo, use un destornillador eléctrico cuya presión de torque sea menor a 10Kg/Cm.)



<Fig. 2>

5.2 Ajuste de Convergencia

(1) Prueba de equipo

1. Bobina desmagnetizadora
2. Jig de fijación de convergencia

(2) Pasos Preliminares

1. Ponga el TV en funcionamiento 30 minutos antes del ajuste.
2. Desmagnetize el CPT y el gabinete con la bobina desmagnetizadora.

- Reciba el patrón Cross Hatch.
- Ajuste el contraste y el brillo para su observación.

(3) Ajuste de convergencia Estática (STC)

- Reciba el patrón Cross Hatch.
- Ajuste el Foco con el ajuste de volumen de foco.
- Abra los magnetos de 4 polos hasta que las líneas verticales rojas y azules se unifiquen.
- Rote los magnetos de 4 polos manteniendo el ángulo entre los dos magnetos de 4 polos hasta que las líneas horizontales roja y azul se unifiquen.
- Abra los magnetos de 6 polos hasta que el ajuste horizontal la línea Magenta (rojo y azul) y verde se unifiquen.
- Rote los magnetos de 6 polos hasta que la línea vertical magenta (rojo y azul) y la línea verde se unifiquen.

(4) Ajuste de Convergencia Dinámica (DYC)

- Ajuste de Línea Vertical : Ajuste moviendo el yugo a la derecha y a la izquierda.
- Ajuste de Línea Horizontal : Ajuste moviendo el yugo hacia arriba y hacia abajo.

5.3 Bloque para ajuste de Pureza y Convergencia

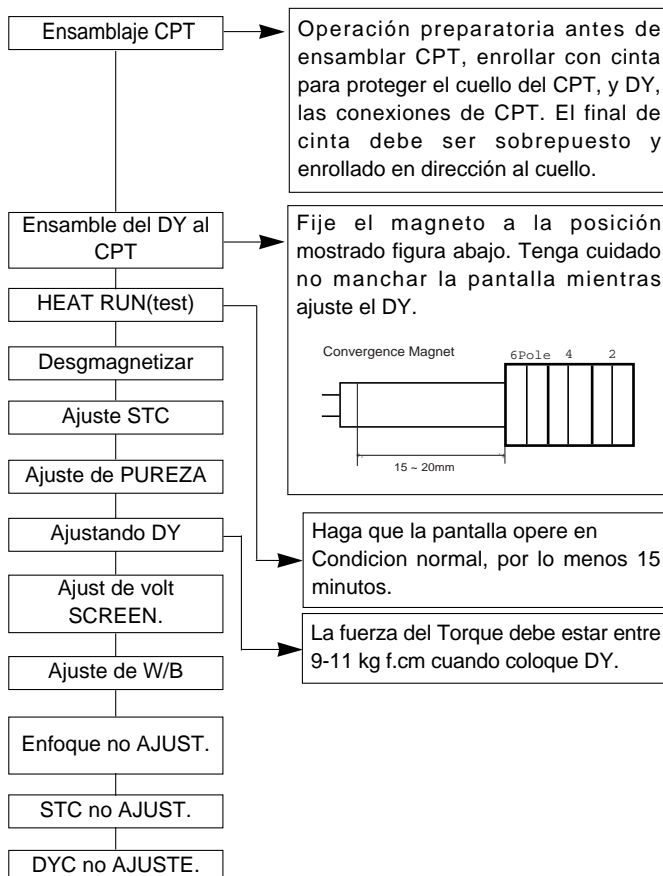

6. Ajuste de Balance de Blanco

6.1 Equipo de Prueba

- Medidor automático de balance de blanco (Puede generar patrones de alta o baja luminosidad)
- Medidor de balance de blanco (CRT Analizador de color, CA-100)
- Control remoto SVC para los ajustes.

6.2 Pasos Preliminares

Realice los ajustes del screen primero.

6.3 Ajuste (Automatico)

- Ajuste usando el medidor automatico de balance de blanco.
- Ajustando en modo de CPU OFF presionando IN-START, el boton de MUTE en control remoto de SVC. Después de finalizar el ajuste, presione el boton TV/AV para salir.

6.4 Ajuste(Manual)

- El balance de blanco puede ajustarse con el control remoto SVC.
- Entre en el modo de ajuste presionando el botón IN-START.
- Ajuste el item con CH ▲, ▼.
- Ajuste los datos con VOL ◀, ▶.

(5) Procedimientos de Ajuste

- Ajuste el contraste y el brillo hasta que la señal del área de alta luminosidad sea 45Ft_L.
- Seleccione el R-DRIVE(VP 7) y ajuste la coordenada X en Alta luminosidad y seleccione B-DRIVE(VP 9) y ajuste la coordenada Y de manera que las coordenadas del color en alta luminosidad tenga los valores de la Tabla de abajo.
- Ajuste el contraste y el brill de manera que el nivel del brillo sea 4.5Ft_L.
- Seleccione R BIAS(VP 4) y ajuste la coordenada X en baja luminosidad y seleccione B BIAS(VP 6) y ajuste la coordenada Y de manera que las coordenadas del color en baja luminosidad tenga los valores de la Tabla de abajo.
- Repita los pasos del 1 ~ 4 hasta obtener las coordenadas del color en alta y baja luminosidad
- Revise los resultados del ajuste utilizando un medidor de balance de blanco.

Temperatura del color	Coordenada X	Coordenada Y
12,000; 800	0.270; 0.003	0.283; 0.003

11. IIC BUS Tabla de datos de ajuste

Menú	OSD	Ajuste	Rango	Ajuste Inicial	Remark
VP 0	RF AGC	RF AGC Delay	0 ~ 63	40	Necessary
VP 1	H POS	H PHASE	0 ~ 31	15	Necessary
VP 2	V POS	V Shift(V POSI)	0 ~ 15	6	Necessary
VP 3	V SIZE	Vertical Size	0 ~ 127	83	Necessary
VP 4	R BIAS	Red Bias	0 ~ 255	127	Necessary
VP 5	G BIAS	Green Bias	0 ~ 255	100	Unnecessary
VP 6	B BIAS	Blue Bis	0 ~ 255	127	Necessary
VP 7	R DRIVE	Red Drive	0 ~ 127	64	Necessary
VP 8	G DRIVE	Green Drive	0 ~ 15	8	Unnecessary
VP 9	B DRIVE	Blue Drive	0 ~ 127	64	Necessary
VP 10	V LIN	V LIN(Vertical Linearity)	0 ~ 31	24	Unnecessary
VP 11	V S-CORR	Vertical S-Correction	0 ~ 31	10	Unnecessary
VP 12	V COMP	V.COMP	0 ~ 3	3	Unnecessary
VP 13	H BLK L	H BLK L	0 ~ 3	0	Unnecessary
VP 14	H BLK R	H BLK R	0 ~ 3	3	Unnecessary
VP 15	AFC GAIN	AFC Gain & gate	0 / 1	0	Unnecessary
VP 16	H FREQ	H Freq.	0 ~ 63	15	Unnecessary
VP 17	CD MODE	Count Down Mode	0 ~ 7	0	Unnecessary
VP 18	VBLK SW	VBLK SW	0 / 1	0	Unnecessary
VP 19	FBP SW	FBP Blanking OR SW	0 / 1	1	Unnecessary
VP 20	YC FILTER	Filter System	0 ~ 15	0	Unnecessary
VP 21	Y APF	Y APF Select	0 / 1	0	Unnecessary
VP 22	C SYSTEM	Color System	0 ~ 7	1	Unnecessary
VP 23	C VCO	C/VCO Adjustment	0 ~ 7	4	Unnecessary
VP 24	PAL APC	PAL APC SW	0 / 1	0	Unnecessary
VP 25	S TRAP SW	S.TRAP.SW	0 / 1	1	Unnecessary
VP 26	VIF SYS	VIF System SW	0 ~ 3	3	Unnecessary
VP 27	VCO FREQ	VCO Freq	0 ~ 63	28	Unnecessary
VP 28	SIF SYS	SIF System SW	0 ~ 3	0	Unnecessary
VP 29	SUB BIAS	SIF Bias(sub-bright)	0 ~ 127	70	Unnecessary
VP 30	BRIGHT	Brightness Control	0 ~ 127	64	Unnecessary
VP 31	ABL	Bright ABL Defeat	0 / 1	1	Unnecessary
VP 32	BRI STOP	Bright Mid Stop Defeat	0 / 1	0	Unnecessary
VP 33	ABL TH	Bright ABL Threshold	0 ~ 7	4	Unnecessary
VP 34	RGB TEMP	RGB Temp SW	0 / 1	0	Unnecessary
VP 35	COR GAIN	Coring Gain Select	0 ~ 3	0	Unnecessary
VP 36	PRE SHOOT	Pre-shoot Adjustment	0 ~ 3	0	Unnecessary

Menú	OSD	Ajuste	Rango	Ajuste Inicial	Remark
VP 37	OVER SHOOT	Over-shoot Adjustment	0 ~ 3	3	Unnecessary
VP 38	Y GAMMA	Y Gamma start point Select	0 ~ 3	0	Unnecessary
VP 39	DC REST	DC Restoration Select	0 ~ 3	1	Unnecessary
VP 40	B-ST START	Black Stretch Start Point	0 ~ 3	1	Unnecessary
VP 41	B-ST GAIN	Black Stretch Gain Select	0 ~ 3	2	Unnecessary
VP 42	C BYPASS	C Bypass	0 / 1	0	Unnecessary
VP 43	C KILL ON	C Kill On	0 / 1	0	Unnecessary
VP 44	C KILL OFF	C Kill Off	0 / 1	0	Unnecessary
VP 45	C KILL OPER	Color Killer Operational Point Select	0 ~ 7	7	Unnecessary
VP 46	RB BAL	R/B Gain Balance	0 ~ 15	5	Unnecessary
VP 47	RB ANG	R/B Angle	0 ~ 15	5	Unnecessary
VP 48	B-Y LEVEL	B-Y DC Level	0 ~ 15	11	Unnecessary
VP 49	R-Y LEVEL	R-Y DC Level	0 ~ 15	10	Unnecessary
VP 50	V LEVEL	Video Level	0 ~ 7	7	Unnecessary
VP 51	OVER MO SW	OVER.MOD.SW	0 / 1	0	Unnecessary
VP 52	OVER MO LE	OVER.MOD.LEVEL	0 ~ 15	8	Unnecessary
VP 53	TINT TH	Tint Through	0 / 1	0	Unnecessary
VP 54	Y TH	Y TH	0 ~ 3	1	Unnecessary
VP 55	Y GAIN	Y Gain	0 ~ 3	0	Unnecessary
VP 56	R WIDTH	R width	0 ~ 3	0	Unnecessary
VP 57	R OFFSET	R offset	0 ~ 3	0	Unnecessary
VP 58	B WIDTH	B width	0 ~ 3	0	Unnecessary
VP 59	B OFFSET	B offset	0 ~ 3	0	Unnecessary
VP 60	T DISABLE	T Disable	0 / 1	1	Unnecessary
VP 61	V TRANCE	V TRANCE	0 / 1	0	Unnecessary
VP 62	A MUTE	Audio Mute	0 / 1	0	Unnecessary
VP 63	V MUTE	Video Mute	0 / 1	0	Unnecessary
VP 64	SYNC KILL	Sync Kill	0 / 1	0	Unnecessary
VP 65	V KILL	Vertical Kill	0 / 1	0	Unnecessary
VP 66	FSC SW	SVO or fsc Output	0 / 1	0	Unnecessary
VP 67	GRAY	Gray Mode	0 / 1	0	Unnecessary
VP 68	CROSS BW	Cross B/W	0 ~ 3	0	Unnecessary
VP 69	H-TONE	Half Tone	0 ~ 3	0	Unnecessary
VP 70	RGB BLK	Blank Defeat	0 / 1	0	Unnecessary
VP 71	C EXT	C Ext	0 / 1	0	Unnecessary
VP72	CRCB IN	CbCr IN	0 / 1	0	Unnecessary
VP73	AUDIO SW	Audio SW	0 / 1	0	Unnecessary
VP 74	VOL FIL	VOL.FIL	0 / 1	0	Unnecessary
VP 75	FM MUTE	FM Mute	0 / 1	0	Unnecessary

Menú	OSD	Ajuste	Rango	Ajuste Inicial	Remark
VP 76	IF AGC	IF AGC Defeat	0 / 1	0	Unnecessary
VP 77	A-OUT SW	A.MONI.SW	0 / 1	0	Unnecessary
VP 78	DE-EMPH	De-emphasis TC	0 / 1	1	Unnecessary
VP 79	FM GAIN	FM Gain	0 / 1	1	Unnecessary
VP 80	S TRAP	S Trap Test	0 ~ 7	4	Unnecessary
VP 81	C TRAP	C. Trap Test	0 ~ 7	4	Unnecessary
VP 82	FLESH	Auto-Flesh	0 / 1	0	Unnecessary
VP 83	OSD CONT	OSD Contrast	0 ~ 3	0	Unnecessary

12. IIC BUS Tabla de datos de ajuste(SUB)

Menú	OSD	Ajuste	Rango	Ajuste Inicial	Remark
VP 85	SUB-BRIGHT		0 ~ 100	40	Necessary
VP 86	SUB TINT		-20(R) ~ +20(G)	0	Unnecessary

MEMO

VISTA EN DESPIECE

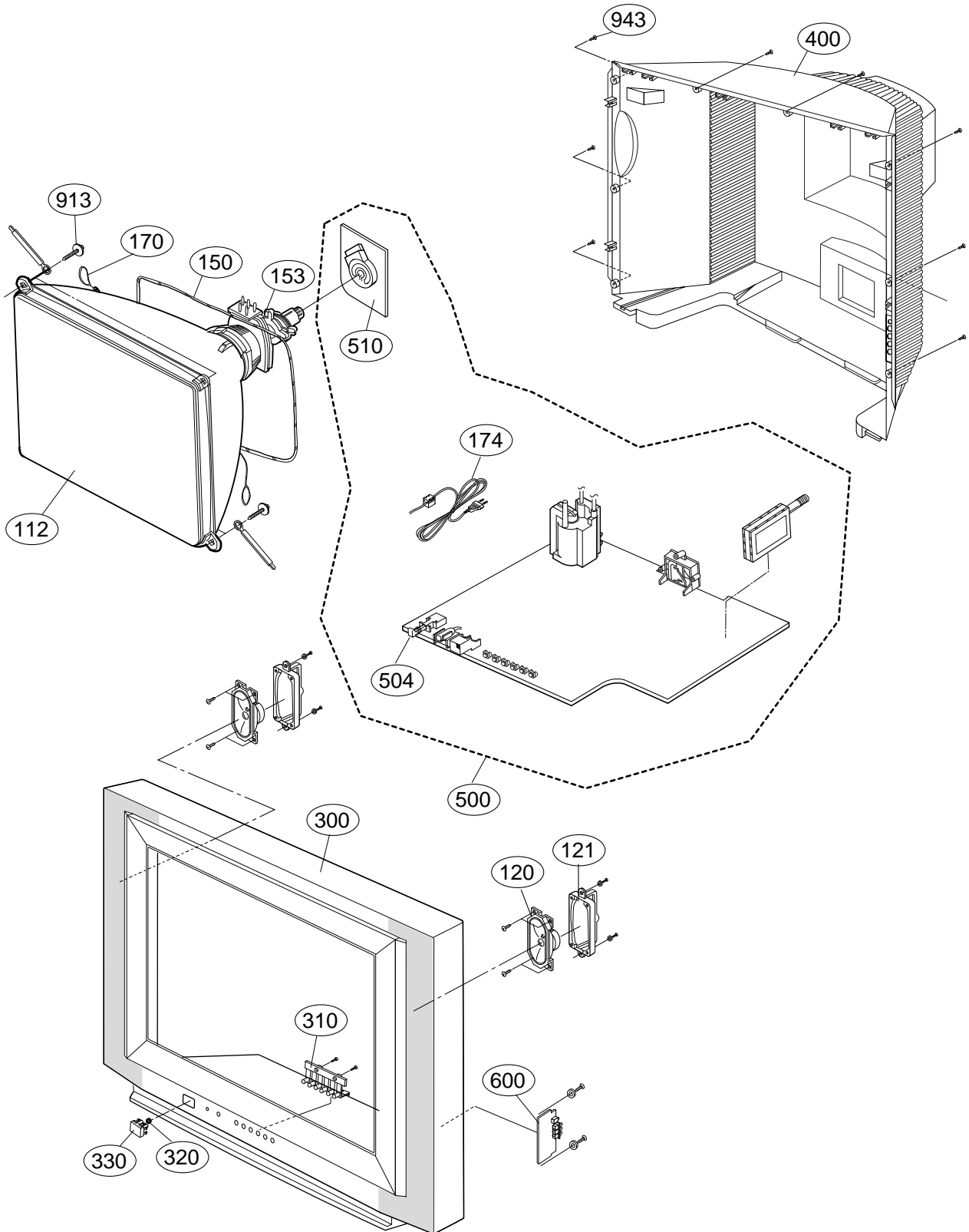

LISTA DE VISTA EN DESPIECE

No.	Part No.	Description
112	6334V21009A	CPT,A51QDJ420X 01 LG-PHILIPS DISPLAYS 16KHZ BARE AK MASK
120	6400VA0001A	SPEAKER,FULLRANGE KK BUKDOO 8 OHM 5/12W 82 DB 110*50
121	4810V01183A	BRACKET,SPEAKER RP-21FX40 SC023A ABS LGERS
150	150-D02T	COIL,DEGAUSSING AL 21 56T 12 OHM
153	6150V-1014J	DY,6150Z-1227A 21 LG SLIM
170	170-A01N	CPT EARTH,21 64T 2LUG 1P HSG CL-21Q20ET(PC-99DA)
174	174-019N	POWER CORD,W/HOLDER,HOUSING L=200
300	3091V00838B	CABINET ASSEMBLY,21FX5RG-LD BRAND MC059A LGERS LOCAL
	3091V00838C	CABINET ASSEMBLY,21FX5RF-LD LGERS LOCAL
310	5020V01103B	BUTTON,CONTROL 21FX5RG-LD ABS, HF-380 6KEY LGERS C/SKD
320	320-062H	SPRING,COIL
330	5020V01102B	BUTTON,POWER 21FX5RG-LD ABS, HF-380 1KEY LGERS C/SKD
400	3809V00598B	BACK COVER ASSEMBLY,21FX5RG-LD DVD(1PHONE) LGERS LOCAL
500	3141VMNZW1A	CHASSIS ASSEMBLY,MAIN MC059A 21F/ST/FX4/LPD/RS-EX/G/V/S
	3141VMNZW1H	CHASSIS ASSEMBLY,MAIN MC059A 21F/ST/FX5/LPD/RS-EX/V/FM/S
504	351-012A	LINK,POWER 5.5*18 ABS, HF-380 .
510	6871VSN901A	PCB ASSEMBLY,SUB CRTMIN MC059A 21/15FLAT CPT B/D SVC ASSY
600	6871VSMAFDC	PCB ASSEMBLY,SUB A/V MC059A M-IN/SIDE/ST/9041/RS
912	332-240B	SCREW,DRAWING P TYPE D4.0 16.0MM FZMY-1 WITH WASHER D14
913	332-057B	SCREW ASSY,HEXAGON HEAD
943	1PTF0403116	SCREW TAP TITE(P),TRUSS HEAD

LISTA DE PARTES DE REPUESTO

For Capacitor & Resistors, the characters at 2nd and 3rd digit in the P/No. means as follows;	CC, CX, CK, CN : Ceramic CQ : Polyester CE : Electrolytic	RD : Carbon Film RS : Metal Oxide Film RN : Metal Film RF : Fusible
---	---	--

RUN DATE : 2005.7.14

LOCA. NO	PART NO	DESCRIPTION
IC		
HIC211	0IZZVF0025B	7PIN FM TRANSMITTER
HIC291	0IZZVC0122A	8P BK 15GAME NTSC HYBRID
IC02	0IMCRAL011A	AT24C04-10PI-2.7 8P EEPROM 4K
IC301	0IPRPSA006B	LA78040N 7Z BK 1.5A VERT. OUT
IC501	0ICTMSA002C	LG6319R56N1-E 64P MC059A REMASKING
IC601	0IPMGSA024B	LA42072NLG-E 13P ST 7W 2CH AUDIO
IC661	0IMCRMN013A	MSP3425G PO B8 V3 52P SOUND
IC662	0IPMGA0006A	AZ7033Z AAC TO-92 3P TP 3.3V
IC751	0IPRPSA018A	LA7958N-E 22P A/V SWITCHING
IC801	0IPMGSK016A	STR-W6753 6PIN TO220F-6L
IC802	0IPRPKD003A	PC17L1 4P/DIP ST PHOTO COUPLER
IC803	0IKE780500Q	KIA7805API 3P TO-220
IC804	0IMCRKE002B	KIA78R09API 4P TO-220IS ST 9V/1A
IC805	0ISK110000A	SE110N(LF12) 3P 110V ERROR AMP
TRANSISTOR		
Q10	0TR534309AA	2SC5343Y TP AUK
Q16	0TR102009AB	KRC102M,TP(KRC1202),KEC
Q241	0TR126609AA	KTA1266-Y(KTA1015) TO92 PNP
Q301	0TR103009AD	KRC103M(AT) TO-92M TP KEC
Q401	0TR322809AA	KTC3228-0 TP(KTC2383),KEC
Q402	0TRSA10004A	TT2170LS-YB11 TO-220FM 1500V 5A
Q403	0TR421009CC	BF421(PNP) TO92 VCBO -300V
Q601	0TR126609AA	KTA1266-Y(KTA1015) TO92 PNP
Q671	0TR126609AA	KTA1266-Y(KTA1015) TO92 PNP
Q672	0TR126609AA	KTA1266-Y(KTA1015) TO92 PNP
Q801	0TR534309AA	2SC5343Y TP AUK
Q813	0TR102009AB	KRC102M,TP(KRC1202),KEC
Q901	0TR233009CA	KSC2330-Y TP SAMSUNG TO-92L -
Q902	0TR233009CA	KSC2330-Y TP SAMSUNG TO-92L -
Q903	0TR233009CA	KSC2330-Y TP SAMSUNG TO-92L -
DIODE		
D301	0DD060009AC	TVR06J 600V 250NSEC -
D302	0DD400509AA	1N4005 DO204AL 600V 1A 30A
D303	0DSGF00019A	1N4148 DO35 100V 0.15A 2A
D403	0DSGF00019A	1N4148 DO35 100V 0.15A 2A
D405	0DSGF00019A	1N4148 DO35 100V 0.15A 2A
D501	0DSGF00019A	1N4148 DO35 100V 0.15A 2A
D502	0DSGF00019A	1N4148 DO35 100V 0.15A 2A
D505	0DD060009AC	TVR06J 600V 250NSEC -
D601	0DSGF00019A	1N4148 DO35 100V 0.15A 2A
D602	0DSGF00019A	1N4148 DO35 100V 0.15A 2A
D603	0DSGF00019A	1N4148 DO35 100V 0.15A 2A
D604	0DSGF00019A	1N4148 DO35 100V 0.15A 2A
D801	0DD100009AM	EU1ZV(1) 200V 0.25A 15A 0.4US 10UA
D802	0DD100009AM	EU1ZV(1) 200V 0.25A 15A 0.4US 10UA

LOCA. NO	PART NO	DESCRIPTION
D803	0DD100009AM	EU1ZV(1) 200V 0.25A 15A 0.4US 10UA
D813	0DD300009AC	RU3AMV(1) 600V 1.5A 50A 0.4US 10UA
D815	0DD060009AC	TVR06J 600V 250NSEC -
D824	0DRTW00141A	SFAF504G ITO220 200V
D826	0DD300009AC	RU3AMV(1) 600V 1.5A 50A 0.4US 10UA
D901	0DR140039AC	1N4003E A405 200V 1A -
D902	0DSGF00019A	1N4148 DO35 100V 0.15A 2A
D903	0DR140039AC	1N4003E A405 200V 1A -
DB801	0DRTW00131A	D2SB60 600V 1.5A .A .SEC 10UA
LD11	0DLLT0020AA	LED,LTL-4223 BK RED 19MCD
ZD102	0DZ510009BF	ZENERS,GDZ5.1B
ZD103	0DZ300009AG	ZENERS,GDZJ30B
ZD412	0DZ910009BD	ZENERS,GDZJ9.1B
ZD601	0DZ510009BF	ZENERS,GDZ5.1B
ZD801	0DZ620009AH	ZENERS,MTZJ6.2A
ZD802	0DZ510009BF	ZENERS,GDZ5.1B
ZD804	0DZ510009BF	ZENERS,GDZ5.1B
ZD851	0DZ620009AH	ZENERS,MTZJ6.2A
CAPACITOR		
C101	0CN1030F679	10000PF D 16V 20%
C103	0CE106DK618	10UF STD 50V M
C107	0CN1020K519	1000PF D 50V 10%
C108	0CE337DD618	330UF STD 10V M
C11	0CC1800K415	18PF D 50V 5% NP0 TR
C110	0CE106DF618	10UF STD 16V M
C12	0CC1800K415	18PF D 50V 5% NP0 TR
C1226	0CE107DD618	100UF STD 10V M
C1227	0CE107DD618	100UF STD 10V M
C132	0CE107DF618	100UF STD 16V M
C14	0CE337DD618	330UF STD 10V M
"	0CE227DD618	220UF STD 10V M *21FX5RF
C15	0CE334DK618	0.33UF STD 50V 20%
C16	0CE225DK618	2.2UF STD 50V 20%
C17	0CQ3331N509	0.033UF D 100V 10%
C19	0CN1010K519	100PF D 50V 10%
C210	181-007C	MPE ECQ-V1H104JL3(TR), 50V 0.1UF J
C211	181-007C	MPE ECQ-V1H104JL3(TR), 50V 0.1UF J
C212	181-007H	MPE ECQ-V1H474JL3(TR), 50V 0.47UF J
C233	0CN2220F569	2200PF D 16V 10%
C234	0CN2220F569	2200PF D 16V 10%
C242	0CE475DK618	4.7UF STD 50V 20%
C243	0CE475DK618	4.7UF STD 50V 20%
C246	0CE227DD618	220UF STD 10V M
C26	0CE337DD618	330UF STD 10V M
C28	0CE107DD618	100UF STD 10V M
C280	0CE475DK618	4.7UF STD 50V 20%
C281	0CE475DK618	4.7UF STD 50V 20%
C293	0CN1020K519	1000PF D 50V 10%

For Capacitor & Resistors, the characters at 2nd and 3rd digit in the P/No. means as follows;	CC, CX, CK, CN : Ceramic CQ : Polyester CE : Electrolytic	RD : Carbon Film RS : Metal Oxide Film RN : Metal Film RF : Fusible
---	---	--

LOCA. NO	PART NO	DESCRIPTION
C294	0CN1030F679	10000PF D 16V 20%
C295	0CE106DF618	10UF STD 16V M
C30	0CN1030F679	10000PF D 16V 20%
C301	0CQ3921N409	0.0039UF D 100V 5%
C303	0CK4710W515	470PF D 500V 10%
C305	0CQ6831N509	0.068UF D 100V 10%
C306	0CQ4731N509	0.047UF D 100V 10%
C307	0CE107DJ618	100UF STD 35V M
C308	0CE476DF618	47UF STD 16V M
C309	0CE227DJ618	220UF STD 35V M
C310	0CQ1041N409	0.1UF D 100V 5%
C312	0CE474DK618	0.47UF STD 50V 20%
C313	0CE106DK618	10UF STD 50V M
C314	0CQ1041N409	0.1UF D 100V 5%
C321	0CE108DH618	1000UF STD 25V M
C322	0CN1020K519	1000PF D 50V 10%
C40	0CE107DD618	100UF STD 10V M
C404	0CK4710W515	470PF D 500V 10%
C407	0CE106DH618	10UF STD 25V 20%
C408	0CE225DP618	2.2UF STD 160V 20%
C409	0CE227DD618	220UF STD 10V M
C412	181-013N	MPP 400V 0.27UF J
C413	0CK2220W515	2200PF D 500V 10%
C414	181-015D	MPP 1600V 0.0062UF H
C415	0CE475DK618	4.7UF STD 50V 20%
C417	181-091W	R 470PF 2KV 10%,-10%
C50	0CN2210K519	220PF D 50V 10%
C502	0CN2230H949	22000PF D 25V 80%,-20%
C509	0CE106DK618	10UF STD 50V M
C51	0CN2210K519	220PF D 50V 10%
C510	0CN1030F679	10000PF D 16V 20%
C511	0CE107DD618	100UF STD 10V M
C512	0CF4741L438	0.47UF D 63V 5%
C513	181-007F	MPE ECQ-V1H224JL3(TR), 50V 0.22UF J
C514	181-009R	PP 200V 0.022UF K
C515	0CE227DD618	220UF STD 10V M
C516	0CQ1531N509	0.015UF D 100V 10%
C517	0CE335DK618	3.3UF STD 50V 20%
C518	0CE107DD618	100UF STD 10V M
C519	0CN1030F679	10000PF D 16V 20%
C521	0CE107DD618	100UF STD 10V M
C523	0CE477DD618	470UF STD 10V 20%
C524	0CE474DK618	0.47UF STD 50V 20%
C526	0CE107DD618	100UF STD 10V M
C527	181-007G	MPE ECQ-V1H334JL3(TR), 50V 0.33UF J
C528	0CN1030F679	10000PF D 16V 20%
C529	0CE105DK618	1UF STD 50V M
C530	0CE225DK618	2.2UF STD 50V 20%
C531	0CE474DK618	0.47UF STD 50V 20%
C532	0CN1040K949	0.1UF D 50V 80%,-20%
C533	0CQ4731N509	0.047UF D 100V 10%
C534	0CN1030F679	10000PF D 16V 20%

LOCA. NO	PART NO	DESCRIPTION
C535	0CN1030F679	10000PF D 16V 20%
C536	0CE105DK618	1UF STD 50V M
C537	0CN1010K519	100PF D 50V 10%
C539	0CN1010K519	100PF D 50V 10%
C540	0CE475DR618	4.7UF STD 250V 20%
C541	0CN1510K519	150PF D 50V 10%
C542	0CQ1831N509	0.018UF D 100V 10%
C544	0CN2230H949	22000PF D 25V 80%,-20%
C56	0CN4710K519	470PF D 50V 10%
C602	0CE226DF618	22UF STD 16V M
C603	0CE475DK618	4.7UF STD 50V 20%
C604	0CQ1831N509	0.018UF D 100V 10%
C605	0CE476DF618	47UF STD 16V M
C606	181-007C	MPE ECQ-V1H104JL3(TR), 50V 0.1UF J
C607	0CE106DF618	10UF STD 16V M
C608	0CE106DF618	10UF STD 16V M
C609	0CQ1831N509	0.018UF D 100V 10%
C610	0CE475DK618	4.7UF STD 50V 20%
C611	0CE476DH618	47UF STD 25V 20%
C612	181-007C	MPE ECQ-V1H104JL3(TR), 50V 0.1UF J
C613	181-007C	MPE ECQ-V1H104JL3(TR), 50V 0.1UF J
C614	181-007C	MPE ECQ-V1H104JL3(TR), 50V 0.1UF J
C661	0CN1010K519	100PF D 50V 10%
C662	0CN1010K519	100PF D 50V 10%
C664	0CN1030F679	10000PF D 16V 20%
C665	0CN1030F679	10000PF D 16V 20%
C666	0CE335DK618	3.3UF STD 50V 20%
C667	0CN3320F569	3300PF D 16V 10%
C668	0CN3320F569	3300PF D 16V 10%
C670	0CE106DF618	10UF STD 16V M
C672	0CE106DF618	10UF STD 16V M
C673	0CN1030F679	10000PF D 16V 20%
C674	0CN1030F679	10000PF D 16V 20%
C675	0CE106DF618	10UF STD 16V M
C680	0CN1030F679	10000PF D 16V 20%
C681	0CE106DF618	10UF STD 16V M
C684	0CN1030F679	10000PF D 16V 20%
C685	0CE106DF618	10UF STD 16V M
C686	0CX1000K409	10PF D 50V 5% SL
C687	0CX5600K409	56PF D 50V 5% SL
C688	0CX5600K409	56PF D 50V 5% SL
C689	0CC0200K115	2PF D 50V 0.5 PF NP0 TR
C690	0CC0200K115	2PF D 50V 0.5 PF NP0 TR
C699	0CE227DD618	220UF STD 10V M
C702	0CE106DF618	10UF STD 16V M
C704	0CE106DF618	10UF STD 16V M
C756	0CE106DF618	10UF STD 16V M
C757	0CE105DK618	1UF STD 50V M
C758	0CE105DK618	1UF STD 50V M
C759	0CE105DK618	1UF STD 50V M
C760	0CE105DK618	1UF STD 50V M
C761	0CE105DK618	1UF STD 50V M

For Capacitor & Resistors, the characters at 2nd and 3rd digit in the P/No. means as follows;

CC, CX, CK, CN : Ceramic	RD : Carbon Film
CQ : Polyester	RS : Metal Oxide Film
CE : Electrolytic	RN : Metal Film
	RF : Fusible

LOCA. NO	PART NO	DESCRIPTION
C762	0CE105DK618	1UF STD 50V M
C763	0CE106DF618	10UF STD 16V M
C764	0CN1030F679	10000PF D 16V 20%
C765	0CE106DF618	10UF STD 16V M
C766	0CE107DF618	100UF STD 16V M
C767	0CN1030F679	10000PF D 16V 20%
C802	0CQZVBK002A	A.C 275V 0.1UF M (S=15)
C803	181-001F	CE 400V 220UF M LUG (85)
C804	0CK10201515	1000PF D 1KV 10%
C805	0CK10201515	1000PF D 1KV 10%
C809	0CE105DK618	1UF STD 50V M
C810	0CE336DK618	33UF STD 50V M
C811	181-011B	0.001UF D 1.6KV J
C812	0CK4710W515	470PF D 500V 10%
C813	181-091R	R 1000PF 1KV 10%,-10%
C814	0CE227DP61A	220UF STD 160V 20%
C815	0CK8210K515	820PF D 50V 10%
C816	0CE107CP618	100UF SHL,SD 160V 20%
C817	0CK1040K945	0.1UF D 50V 80%,-20%
C818	0CQ4731N509	0.047UF D 100V 10%
C819	0CK1520K515	1500PF D 50V 10%
C821	0CK4710W515	470PF D 500V 10%
C826	0CE108DF618	1000UF STD 16V M
C831	0CE107DF618	100UF STD 16V M
C833	0CE107DD618	100UF STD 10V M
C835	0CE107CP618	100UF SHL,SD 160V 20%
C843	181-120K	2200PF 4KV M
C850	0CE108DF618	1000UF STD 16V M
C853	0CE107DD618	100UF STD 10V M
C901	0CE475DR618	4.7UF STD 250V 20%
C902	0CN2710K519	270PF D 50V 10%
C904	0CN2710K519	270PF D 50V 10%
C907	0CN3910K519	390PF D 50V 10%
C908	0CK12202510	1200PF D 2KV 10%
COIL & TRANSFORMER		
J709	0LA0102K119	INDUCTOR,10UH K
L401	150-L02C	COIL,LINEARITY 170UH
L402	6140VB0001F	COIL,CHOKE 130UH
L502	0LA0102K119	INDUCTOR,10UH K
L662	0LA0152K119	INDUCTOR,15UH 10% A
L802	150-C02F	COIL,CHOKE 82UH
T402	6174V-6006W	FBT,BSC25-N0352 21
T403	151-C02B	TRANSFORMER,HDRIVER EI-2519 01UH
T803	6170VMCA43L	TRANSFORMER,SMPS[COIL] EER3940 380UH
WAFER		
P101	366-921B	CONNECTOR,WAFER 3PIN 2.54MM
P201	366-921E	WAFER,IL-G-06 LGC 2.5MM
P211A	366-921C	CONNECTOR,WAFER IL-G-04
P401	366-043K	WAFER,PLUG(4P)
P601	366-921B	CONNECTOR,WAFER 3PIN 2.54MM

LOCA. NO	PART NO	DESCRIPTION
P602	366-921C	CONNECTOR,WAFER IL-G-04
P610	366-921D	WAFER,IL-G-05 LGC 2.5MM
P801	366-043B	WAFER ASSY,PLUG(2P)
P802	366-043B	WAFER ASSY,PLUG(2P)
P901	366-009D	CONNECTOR,WAFER 2.36PAI 1P
P901	366-009D	CONNECTOR,WAFER 2.36PAI 1P
CONNECTOR		
C1	387-603E	CONNECTOR ASSEMBLY,9P 2.5MM 430MM
C2	387-917J	CONNECTOR ASSEMBLY,1P NON 500MM
C3	6631V25014H	CONNECTOR ASSEMBLY,3P 2.5MM 800MM
C4	6631V25034H	CONNECTOR ASSEMBLY,4P 2.5MM 350MM
C5	387-916K	CONNECTOR ASSEMBLY,1P NON 600MM
P1203A	387-A05E	CONNECTOR ASSEMBLY,5P 2.5MM 300MM
P1206A	387-A06G	CONNECTOR ASSEMBLY,6P 2.5MM 400MM
P211B	387-A04C	CONNECTOR ASSEMBLY,4P 2.5MM 200MM
JACK		
JA01	6612VJH023A	JACK,RCA PPJ126A 11P
JA1201	6613V00004B	JACK,RCA 3P
JA1202	380-068D	JACK,PHONE UEJ-CV-003
RESISTOR		
C221	0RD2203F609	220K OHM 1/6 W 5.00%
C222	0RD2203F609	220K OHM 1/6 W 5.00%
C232	0RD2203F609	220K OHM 1/6 W 5.00%
C235	0RD2203F609	220K OHM 1/6 W 5.00%
FR301	0RF0101J607	1 OHM 1 W 5.00%
FR401	0RF0241K607	2.4 OHM 2 W 5.00%
FR403	0RF0121K607	1.2 OHM 2 W 5.00%
FR501	0RF0101J607	1 OHM 1 W 5.00%
FR825	0RP0050H709	0.05 OHM 1/2 W 10%
J511	0RD1000F609	100 OHM 1/6 W 5%
R1	0RD6800F609	680 OHM 1/6 W 5%
R108	0RD1802F609	18K OHM 1/6 W 5.00%
R109	0RD1003F609	100K OHM 1/6 W 5%
R110	0RS2702H609	27K OHM 1/2 W 5.00%
R1221	0RD1500A609	150 OHM 1/2 W(7.0) 5.00%
R1222	0RD1500A609	150 OHM 1/2 W(7.0) 5.00%
R132	0RS0392J607	39 OHM 1 W 5.00%
R150	0RD1003F609	100K OHM 1/6 W 5%
R154	0RD1001F609	1K OHM 1/6 W 5%
R16	0RD2401F609	2.4K OHM 1/6 W 5.00%
R17	0RD2201F609	2.2K OHM 1/6 W 5.00%
R18	0RD2701F609	2.7K OHM 1/6 W 5%
R19	0RD4700F609	470 OHM 1/6 W 0.05
R20	0RD3600F609	360 OHM 1/6 W 5.00%
R21	0RD4701F609	4.7K OHM 1/6 W 5%
R22	0RD1003F609	100K OHM 1/6 W 5%
R226	0RD0752F609	75 OHM 1/6 W 5.00%
R23	0RD4701F609	4.7K OHM 1/6 W 5%
R247	0RD5100F609	510 OHM 1/6 W 5.00%

For Capacitor & Resistors, the characters at 2nd and 3rd digit in the P/No. means as follows;	CC, CX, CK, CN : Ceramic CQ : Polyester CE : Electrolytic	RD : Carbon Film RS : Metal Oxide Film RN : Metal Film RF : Fusible
---	---	--

LOCA. NO	PART NO	DESCRIPTION
R249	0RD0752F609	75 OHM 1/6 W 5.00%
R250	0RD0752F609	75 OHM 1/6 W 5.00%
R251	0RD0752F609	75 OHM 1/6 W 5.00%
R252	0RD0752F609	75 OHM 1/6 W 5.00%
R280	0RD2203F609	220K OHM 1/6 W 5.00%
R281	0RD2203F609	220K OHM 1/6 W 5.00%
R301	0RD1502F609	15K OHM 1/6 W 5.00%
R302	0RD1001A609	1K OHM 1/2 W(7.0) 5.00%
R303	0RD0271A609	2.7 OHM 1/2 W(7.0) 5.00%
R304	0RD0221A609	2.2 OHM 1/2 W(7.0) 5.00%
R305	0RN1202F609	12K OHM 1/6 W 5.00%
R306	0RD8202F609	82K OHM 1/6 W 5.00%
R307	0RD6801F609	6.8K OHM 1/6 W 5.00%
R308	0RD4302F609	43K OHM 1/6 W 5.00%
R309	0RD6801F609	6.8K OHM 1/6 W 5.00%
R310	0RD0101A609	1 OHM 1/2 W(7.0) 5.00%
R311	0RD2702F609	27K OHM 1/6 W 5.00%
R312	0RD1502F609	15K OHM 1/6 W 5.00%
R313	0RD4702F609	47K OHM 1/6 W 5%
R315	0RS2200H609	220 OHM 1/2 W 5.00%
R401	0RD0472A609	47 OHM 1/2 W(7.0) 5.00%
R403	0RD2001A609	2K OHM 1/2 W(7.0) 5.00%
R404	0RD1500F609	150 OHM 1/6 W 5.00%
R406	0RS5601K607	5.6K OHM 2 W 5.00%
R407	0RS1002H609	10K OHM 1/2 W 5.00%
R408	0RD7502F609	75K OHM 1/6 W 5.00%
R409	0RD1002F609	10K OHM 1/6 W 5%
R41	0RD1000F609	100 OHM 1/6 W 5%
R410	0RD5101F609	5.1K OHM 1/6 W 5.00%
R413	0RD3300A609	330 OHM 1/2 W(7.0) 5.00%
R414	0RD1002F609	10K OHM 1/6 W 5%
R416	0RS1001J607	1K OHM 1 W 5.00%
R42	0RD1004F609	1M OHM 1/6 W 5%
R420	0RD2403F609	240K OHM 1/6 W 5.00%
R421	0RD3300F609	330 OHM 1/6 W 5.00%
R423	0RD3001F609	3K OHM 1/6 W 5.00%
R43	0RD2703F609	270K OHM 1/6 W 0.05
R501	0RD3301F609	3.3K OHM 1/6 W 5.00%
R505	0RD1000F609	100 OHM 1/6 W 5%
R506	0RD1000F609	100 OHM 1/6 W 5%
R507	0RD1000F609	100 OHM 1/6 W 5%
R508	0RD3901F609	3.9K OHM 1/6 W 5%
R509	0RD3901F609	3.9K OHM 1/6 W 5%
R510	0RD3901F609	3.9K OHM 1/6 W 5%
R512	0RN4701F409	4.7K OHM 1/6 W 1.00%
R513	0RD1200F609	120 OHM 1/6 W 5.00%
R514	0RD2200F609	220 OHM 1/6 W 5.00%
R515	0RD0102F609	10 OHM 1/6 W 5%
R516	0RD2200F609	220 OHM 1/6 W 5.00%
R519	0RD1202F609	12K OHM 1/6 W 5%
R521	0RD7501F609	7.5K OHM 1/6 W 5.00%
R522	0RD2402F609	24K OHM 1/6 W 5.00%

LOCA. NO	PART NO	DESCRIPTION
R523	0RD2403F609	240K OHM 1/6 W 5.00%
R524	0RD6200F609	620 OHM 1/6 W 5.00%
R525	0RD6202F609	62K OHM 1/6 W 5.00%
R526	0RD4702F609	47K OHM 1/6 W 5%
R527	0RD5600F609	560 OHM 1/6 W 5%
R529	0RD0332F609	33 OHM 1/6 W 5.00%
R530	0RD5100F609	510 OHM 1/6 W 5.00%
R531	0RD5100F609	510 OHM 1/6 W 5.00%
R532	0RD3901F609	3.9K OHM 1/6 W 5%
R534	0RD5100F609	510 OHM 1/6 W 5.00%
R536	0RD5100F609	510 OHM 1/6 W 5.00%
R537	0RD3300F609	330 OHM 1/6 W 5.00%
R547	0RD1003A609	100K OHM 1/2 W(7.0) 5.00%
R550	0RS1002H609	10K OHM 1/2 W 5.00%
R561	0RD1000F609	100 OHM 1/6 W 5%
R562	0RD1000F609	100 OHM 1/6 W 5%
R563	0RD1000F609	100 OHM 1/6 W 5%
R564	0RD1000F609	100 OHM 1/6 W 5%
R565	0RD1000F609	100 OHM 1/6 W 5%
R566	0RD4701F609	4.7K OHM 1/6 W 5%
R58	0RD4701F609	4.7K OHM 1/6 W 5%
R601	0RD0221A609	2.2 OHM 1/2 W(7.0) 5.00%
R602	0RD0221A609	2.2 OHM 1/2 W(7.0) 5.00%
R603	0RD0221A609	2.2 OHM 1/2 W(7.0) 5.00%
R604	0RD0221A609	2.2 OHM 1/2 W(7.0) 5.00%
R605	0RD1501F609	1.5K OHM 1/6 W 5%
R607	0RD1002F609	10K OHM 1/6 W 5%
R609	0RD1000F609	100 OHM 1/6 W 5%
R610	0RS0472K607	47 OHM 2 W 5.00%
R611	0RD1501F609	1.5K OHM 1/6 W 5%
R612	0RD5101F609	5.1K OHM 1/6 W 5.00%
R615	0RD1001F609	1K OHM 1/6 W 5%
R616	0RD5101F609	5.1K OHM 1/6 W 5.00%
R617	0RD1802F609	18K OHM 1/6 W 5.00%
R618	0RD1002F609	10K OHM 1/6 W 5%
R620	0RS0681J607	6.80 1W 5%
"	0RS0821K607	8.2 OHM 2W 5.00% *21FX5RF
R65	0RD2200F609	220 OHM 1/6 W 5.00%
R66	0RD3301F609	3.3K OHM 1/6 W 5.00%
R664	0RD1002F609	10K OHM 1/6 W 5%
R665	0RD3901F609	3.9K OHM 1/6 W 5%
R666	0RD3901F609	3.9K OHM 1/6 W 5%
R69	0RD2200F609	220 OHM 1/6 W 5.00%
R701	0RD1000F609	100 OHM 1/6 W 5%
R704	0RD1000F609	100 OHM 1/6 W 5%
R705	0RD1303F609	130K OHM 1/6 W 5.00%
R706	0RD1303F609	130K OHM 1/6 W 5.00%
R707	0RD1503F609	150K OHM 1/6 W 5%
R708	0RD1503F609	150K OHM 1/6 W 5%
R712	0RD0752F609	75 OHM 1/6 W 5.00%
R760	0RD1001F609	1K OHM 1/6 W 5%
R761	0RD1001F609	1K OHM 1/6 W 5%

For Capacitor & Resistors, the characters at 2nd and 3rd digit in the P/No. means as follows;

CC, CX, CK, CN : Ceramic	RD : Carbon Film
CQ : Polyester	RS : Metal Oxide Film
CE : Electrolytic	RN : Metal Film
	RF : Fusible

LOCA. NO	PART NO	DESCRIPTION
R801	180-A03Q	RW RECT G 7W 1.0 J DOUBLE(SP)
R803	0RD4701F609	4.7K OHM 1/6 W 5%
R804	0RS4702K607	47K OHM 2 W 5.00%
R805	0RS4702K607	47K OHM 2 W 5.00%
R806	180-A01N	0.18 OHM 2 W 5% PRW
R807	0RD2200A609	220 OHM 1/2 W(7.0) 5.00%
R808	0RD1501F609	1.5K OHM 1/6 W 5%
R809	0RD1001F609	1K OHM 1/6 W 5%
R810	0RD0472F609	47 OHM 1/6 W 5%
R812	0RD1003F609	100K OHM 1/6 W 5%
R814	0RKZVTA001C	8.2M OHM 1/2 W 5%
R82	0RD4701F609	4.7K OHM 1/6 W 5%
R831	0RD4701F609	4.7K OHM 1/6 W 5%
R832	0RD4701F609	4.7K OHM 1/6 W 5%
R835	0RD1001F609	1K OHM 1/6 W 5%
R883	0RD0822A609	82 OHM 1/2 W(7.0) 5.00%
R884	0RD1201F609	1.2K OHM 1/6 W 5%
R902	0RD2204A609	2.2M OHM 1/2 W(7.0) 5.00%
R905	0RD4300F609	430 OHM 1/6 W 5.00%
R906	0RD1000F609	100 OHM 1/6 W 5%
R908	0RD1801F609	1.8K OHM 1/6 W 5.00%
R912	0RS1802K607	18K OHM 2 W 5.00%
R915	0RD4300F609	430 OHM 1/6 W 5.00%
R916	0RD1000F609	100 OHM 1/6 W 5%
R917	0RS1802K607	18K OHM 2 W 5.00%
R918	0RD1501A609	1.5K OHM 1/2 W(7.0) 5.00%
R919	0RD1501A609	1.5K OHM 1/2 W(7.0) 5.00%
R920	0RD1501A609	1.5K OHM 1/2 W(7.0) 5.00%
R921	0RD1000F609	100 OHM 1/6 W 5%
R922	0RD4300F609	430 OHM 1/6 W 5.00%
R923	0RS1802K607	18K OHM 2 W 5.00%
SWITCH		
SW11	140-315A	SWITCH,TACT SKHV17910B
SW12	140-315A	SWITCH,TACT SKHV17910B
SW13	140-315A	SWITCH,TACT SKHV17910B
SW14	140-315A	SWITCH,TACT SKHV17910B
SW15	140-315A	SWITCH,TACT SKHV17910B
SW16	140-315A	SWITCH,TACT SKHV17910B
SW801	6600VM1001A	SWITCH,PUSH SDKLA1 250V 5A
CRYSTAL & FILTER		
FB801	125-022R	FILTER,EMC BI3857
L804	125-022R	FILTER,EMC BI3857
T802	6200JB8008G	FILTER,EMC SQ2222 7MH
X1	6212AA2998A	RESONATOR,CRYSTAL HLX-308 32.768KHZ
X501	156-A01V	RESONATOR,CRYSTAL HC49U 4.433619MHZ
X661	156-A02M	RESONATOR,CRYSTAL HC49U 18.432MHZ
Z102	6200QL3001B	FILTER,SAW V/C EPCOS ST M1872D
MISCELLANEOUS		
F801	0FS4001B51D	FUSE,SLOW BLOW 4000MA 250V

LOCA. NO	PART NO	DESCRIPTION
PA01	6712SCA226B	REMOTE CONTROLLER RECEIVER,38KHZ
SK901	6620VBC003A	SOCKET,CPT PCS030A 8PIN 14/360
TH801	163-051F	THERMISTOR,PTC J503P84D140M290Q
TU101	6700NFNS11F	TUNER,TAEA-H101F
VD801	164-003G	VARISTOR,TVR621D14A 620V 10%
ACCESSORIES		
A1	3828VA0521H	MANUAL,MC059A GAME TV LGEMS
"	3828VA0521Q	MANUAL,MC059A X-WAVE *21FX5RF
A1	3828VA0393T	MANUAL,GAME LG EN/SP (SOCCER)
A2	6710V00090N	REMOTE CONTROLLER
A3	5010V00003B	ANTENNA,3SECTION 750MM NTSC
A4	450-017C	ADAPTER,RF UGCOM 1.5KV 5MA UMT-NT-006



P/NO : 3828VD0229P

July, 2005
Printed in Korea



< MC-059A SCHEMATIC DIAGRAM >

VERSION 5.1 2005.03.03 MADE BY LEE.D.Y

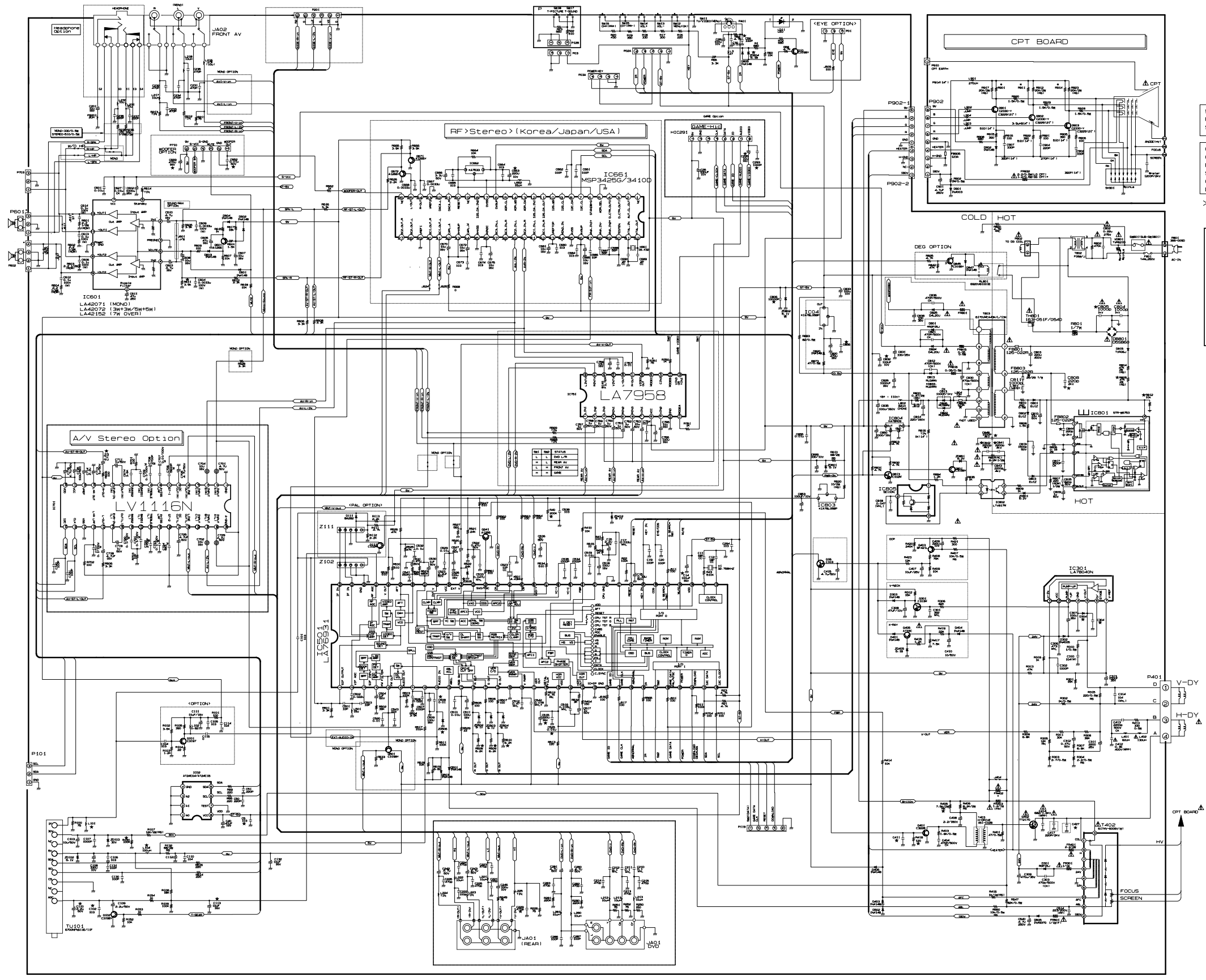

WARNING BEFORE SERVICING THIS CHASSIS-READ 'X-RAY RADIATION PRECAUTION', 'SAFETY PRECAUTION' AND PRODUCT SAFETY NOTICE IN THIS MANUAL.

CAUTION: THE MARKS IN THE SCHEMATIC DIAGRAM AND THE PARTS LIST DESIGNATE COMPONENTS WHICH HAVE SPECIAL CHARACTERISTICS FOR SAFETY, AND SHOULD BE REPLACED ONLY WITH TYPES IDENTICAL TO THOSE IN THE ORIGINAL CIRCUIT OR SPECIFIED IN THE PARTS LIST. BEFORE REPLACING ANY OF THESE COMPONENTS-READ CAREFULLY THE PRODUCT SAFETY NOTICE IN THIS MANUAL. DO NOT DEGRADE THE SAFETY OF THE RECEIVER THROUGH IMPROPER SERVICING.

* : OPTION

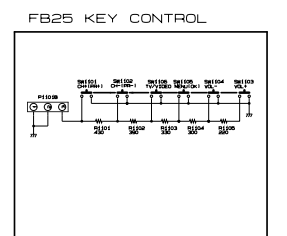
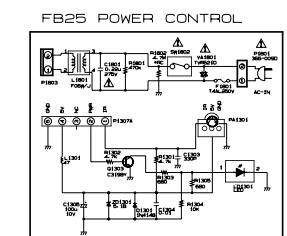

P401 D V-DY
C H-DY
B A
HV
CPT BOARD

TABLERO DE CIRCUITO IMPRESO

MAIN & CPT

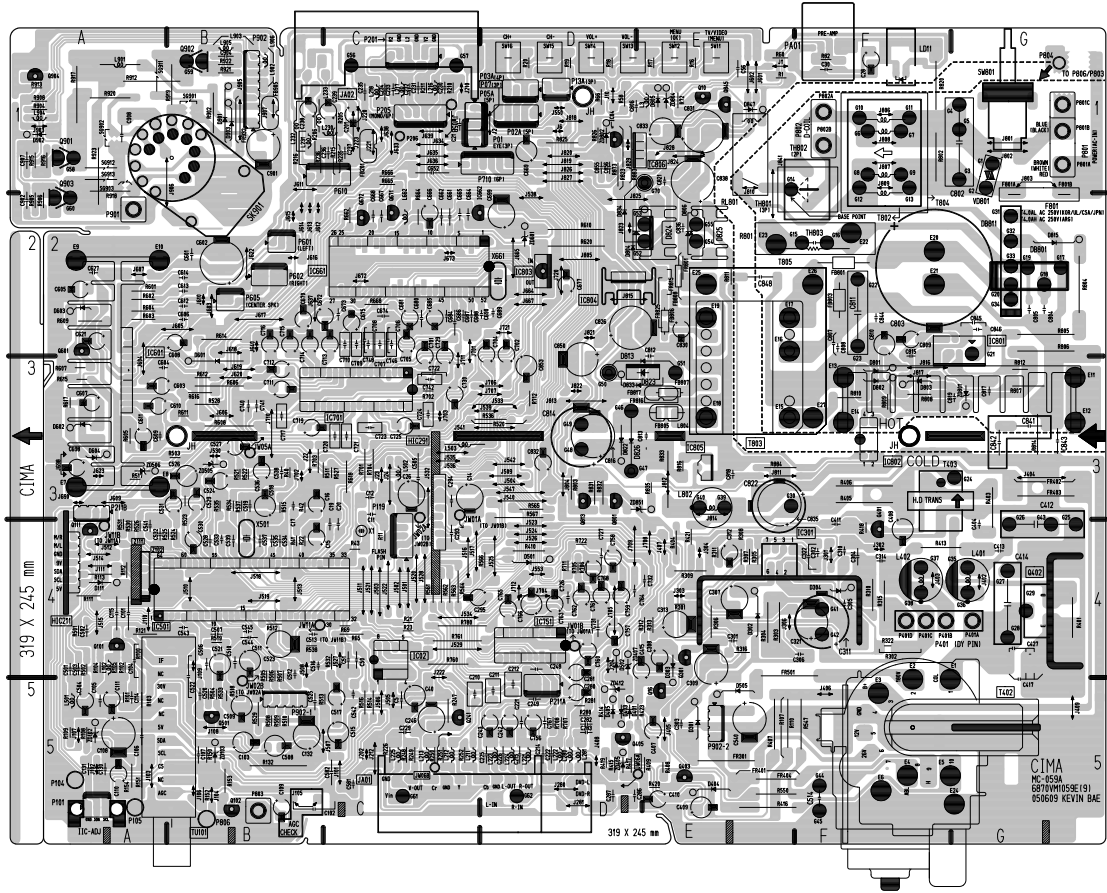

GUÍA PARA UBICAR LOS COMPONENTES

C5.....C5	C281.....D4	C523.....B4	C687.....C2	C807.....F3	D804.....E2	L3.....E1	P801B..G1	R109.....A5	R419.....D5	R608.....B3	R906.....A2
C11.....C4	C282.....D5	C524.....B3	C688.....C2	C808.....F3	D805.....E1	L102.....A4	P801C..G1	R110.....E5	R420.....E5	R609.....A2	R908.....A1
C12.....C3	C283.....D5	C525.....B5	C689.....D2	C809.....F2	D806.....E2	L211.....C5	P802A..F1	R111.....A4	R421.....E4	R610.....D2	R912.....A1
C14.....C3	C286.....D5	C526.....B3	C690.....D2	C810.....F2	D813.....D3	L212.....C5	P802B..F1	R112.....A4	R423.....E5	R611.....B3	R913.....A1
C15.....B4	C287.....D5	C527.....B3	C698.....A3	C811.....F3	D815.....G2	L213.....C5	P902-1..B5	R113.....A4	R501.....A4	R612.....B3	R915.....A1
C16.....B3	C293.....C4	C528.....B4	C699.....D2	C812.....E3	D822.....D3	L216.....C1	P902-2..E5	R132.....B5	R502.....A5	R614.....B2	R916.....A1
C17.....B4	C294.....C3	C529.....B3	C701.....C3	C813.....E3	D823.....E3	L217.....C1	PA01.....F1	R150.....B5	R503.....A3	R615.....A3	R917.....A1
C19.....C4	C307.....E4	C537.....B4	C702.....D3	C814.....D3	D824.....E2	L218.....C1	Q10.....E1	R151.....A5	R504.....B5	R616.....B3	R918.....A2
C20.....C4	C301.....E4	C531.....B3	C704.....D3	C815.....F3	D825.....E2	L221.....D5	Q16.....E1	R152.....B5	R505.....B5	R617.....B3	R919.....B1
C21.....C1	C302.....F4	C532.....A4	C705.....C2	C816.....D3	D826.....D3	L222.....D5	Q101.....A4	R153.....B5	R506.....B5	R618.....C3	R920.....A1
C26.....C3	C303.....E5	C533.....B4	C706.....C3	C817.....G3	D833.....D3	L223.....D5	Q102.....B5	R154.....A5	R507.....B5	R620.....D2	R921.....B1
C28.....F1	C304.....F4	C534.....B4	C707.....C3	C818.....E3	D834.....E2	L224.....D5	Q111.....A4	R205.....C1	R508.....B5	R662.....C2	R922.....B1
C30.....F1	C305.....F4	C535.....B4	C708.....C3	C819.....G3	D847.....E1	L225.....C5	Q241.....C5	R206.....B1	R509.....B5	R664.....C2	R923.....A2
C40.....C5	C306.....E4	C536.....B3	C709.....C3	C821.....E2	D901.....B1	L230.....B1	Q301.....C1	R210.....C1	R510.....B5	R665.....C2	RL801..E1
C50.....C4	C307.....E4	C537.....B4	C710.....C3	C822.....E3	D902.....A1	L231.....B1	Q401.....F4	R211.....C1	R511.....C3	R666.....C1	SG901..B1
C51.....C4	C308.....E4	C538.....B3	C711.....B3	C826.....E2	D902.....B1	L232.....B1	Q402.....G4	R215.....C1	R512.....C5	R668.....C2	SG902..A1
C56.....E1	C309.....E4	C539.....A4	C712.....B3	C830.....E2	D9801..G2	L233.....B1	Q403.....E5	R216.....B1	R513.....C5	R701.....C3	SG903..A2
C101.....A4	C310.....F4	C540.....E5	C713.....C2	C831.....E1	D8811..G2	L280.....D5	Q405.....D5	R226.....C5	R514.....C5	R702.....C3	SG911..A1
C102.....B5	C311.....F4	C541.....A4	C714.....B2	C832.....D3	F801A..G2	L281.....D5	Q501.....B5	R235.....C1	R515.....B4	R703.....B3	SG912..A1
C103.....B5	C312.....E4	C542.....C5	C715.....B2	C833.....E1	F801B..G2	L401.....G4	Q601.....A3	R236.....B1	R516.....C5	R704.....C3	SG913..A2
C104.....A4	C313.....E4	C543.....B4	C716.....B2	C835.....E3	F8201..C1	L402.....F4	Q671.....C2	R247.....C5	R517.....A5	R705.....D4	SK901..B1
C105.....A5	C314.....F4	C544.....A4	C717.....B3	C836.....E2	F801F..F2	L501.....A5	Q672.....C2	R248.....C5	R518.....B5	R706.....D4	SW11.....E1
C106.....A5	C321.....F4	C601.....B2	C718.....B3	C838.....E1	F803F..F2	L502.....C3	Q801.....D3	R249.....C5	R519.....B4	R707.....D5	T403.....G3
C107.....B5	C322.....F4	C602.....B2	C720.....C3	C841.....G3	F805E..E3	L662.....C2	Q813.....D3	R250.....C5	R520.....C3	R708.....D5	SW13..D1
C108.....A5	C404.....G4	C603.....A3	C721.....C3	C842.....G3	F806E..E2	L802.....E3	Q845.....E1	R251.....C5	R521.....B3	R711.....D4	SW14..D1
C109.....B5	C407.....E5	C604.....A3	C722.....C3	C843.....G3	F807E..E3	L804.....E3	Q901.....A1	R252.....C5	R522.....C3	R712.....D3	SW15..D1
C110.....A5	C408.....F4	C605.....A2	C723.....C3	C844.....F2	F808E..E2	L901.....A1	Q902.....B1	R280.....D5	R523.....B3	R722.....D4	SW16..D1
C111.....A5	C409.....E5	C606.....B2	C724.....C3	C845.....G2	F809E..B1	L902.....B1	Q903.....A2	R281.....D5	R524.....B4	R760.....C4	SW801..G1
C114.....A5	C410.....E5	C607.....A3	C725.....C3	C846.....G2	F8301..E5	L903.....B1	Q904.....A1	R301.....E4	R525.....B4	R761.....C4	T402.....F5
C115.....A4	C411.....F4	C608.....B2	C726.....D4	C848.....E2	FR401..E5	L904.....A1	R1.....E1	R302.....F4	R526.....B5	R762.....D5	T403.....G3
C130.....A5	C412.....G4	C609.....A3	C727.....A4	C850.....D3	FR402..G3	L905.....B1	R11.....C4	R303.....E4	R527.....C5	R801.....A2	T802.....F1
C131.....A5	C413.....G4	C610.....A3	C729.....C3	C853.....D3	FR403..G3	L906.....B1	R16.....E1	R304.....E4	R528.....B3	R802.....F2	T803.....E3
C132.....B5	C414.....G4	C611.....A3	C730.....C3	C855.....D1	FR404..E5	LD11.....F1	R17.....E1	R305.....E4	R529.....B5	R803.....D3	T804.....F2
C201.....C1	C415.....E4	C612.....B2	C731.....D4	C856.....D1	FR501..E4	P01.....C1	R18.....D1	R306.....E4	R530.....A4	R804.....G2	T805.....E2
C210.....C5	C417.....G4	C613.....B2	C732.....E4	C901.....B1	FR801..E2	P07.....C1	R19.....D1	R307.....E4	R531.....A4	R805.....G2	TH801..F2
C211.....D5	C427.....G4	C614.....B2	C740.....B3	C902.....A2	FR815..E2	P101.....A5	R20.....D1	R308.....E4	R532.....C4	R806.....G3	TH802..E2
C212.....D5	C501.....A5	C621.....A2	C741.....B3	C904.....B1	FR816..E3	P119.....C4	R21.....C4	R309.....E4	R533.....B5	R807.....G3	TH803..F2
C214.....D5	C502.....A4	C622.....A2	C742.....C3	C907.....A1	FR825..E1	P201.....C1	R22.....B4	R310.....F4	R534.....B4	R808.....F3	TU101..B5
C215.....D5	C503.....A5	C623.....C1	C746.....C3	C908.....A1	FR932..B1	P205.....C1	R23.....C4	R311.....E4	R535.....B4	R809.....F3	VD801..G2
C221.....D5	C504.....A5	C661.....C2	C748.....C3	D111.....A4	HC211..A4	P601.....B2	R40.....B3	R312.....E4	R536.....C3	R810.....F3	X1.....C4
C222.....D5	C505.....C3	C662.....C2	C756.....D5	D301.....E5	HIC291..C4	P602.....B2	R41.....B4	R313.....E4	R537.....B4	R811.....E2	X501..B4
C225.....D5	C506.....B4	C664.....C2	C757.....D5	D302.....E4	IC02.....C4	P605.....B2	R42.....B4	R315.....F4	R538.....B4	R812.....G3	X661..D2
C226.....D5	C507.....B4	C665.....C2	C758.....D4	D303.....E5	IC04.....D1	P610.....B1	R43.....C4	R316.....E4	R547.....F5	R814.....G3	Z102..A4
C229.....C5	C508.....B5	C666.....C2	C759.....D4	D304.....F4	IC05.....D1	P710.....C1	R59.....D1	R401.....G4	R550.....E5	R816.....E3	Z111.....A4
C230.....C1	C509.....B5	C667.....C2	C760.....D4	D401.....G3	IC501.....A4	P803.....B5	R60.....E1	R403.....G4	R561.....C4	R820.....F1	ZD102..A5
C231.....C1	C510.....B4	C668.....C2	C761.....D4	D403.....D5	IC901..A3	P901.....A2	R65.....C4	R404.....E4	R562.....C4	R823.....D2	ZD103..B5
C232.....C1	C511.....B4	C669.....D1	C762.....D4	D404.....E5	IC961..D2	P902.....B1	R66.....D1	R405.....F3	R563.....C4	R825.....D1	ZD405..D5
C233.....C1	C512.....B5	C670.....B2	C763.....D4	D405.....D5	IC962..D2	P02A..D1	R69.....C4	R406.....F3	R564.....C4	R826.....D1	ZD407..D4
C234.....C1	C513.....B4	C672.....C2	C764.....D4	D501.....D4	IC701..C3	P03A..D1	R72.....E1	R407.....E5	R565.....D3	R831.....D3	ZD412..D5
C235.....C1	C514.....F5	C673.....C2	C765.....D4	D602.....D4	IC751..D4	P05A..C1	R82.....F1	R408.....E5	R566.....D4	R832.....D3	ZD505..B3
C236.....C1	C515.....C5	C674.....C2	C766.....D4	D605.....E5	IC801..G2	P13A..D1	R100.....A1	R409.....E5	R567.....D4	R833.....E4	ZD506..A3
C237.....C1	C516.....B4	C675.....C2	C767.....D5	D801.....B3	IC802..F3	P211A..D5	R101.....A5	R410.....D4	R601.....A2	R835.....E3	ZD901..D2
C238.....B1	C517.....C5	C677.....D2	C768.....D4	D802.....A3	IC803..D2	P211B..A4	R102.....A4	R413.....F4	R602.....A2	R873.....D2	ZD801..G3
C239.....C1	C518.....B3	C680.....D2	C802.....G2	D803.....A2	IC804..E2	P401A..G4	R103.....A5	R414.....D5	R603.....A2	R883.....D2	ZD802..D1
C242.....D5	C519.....B4	C681.....C2	C803.....F2	D804.....A3	IC805..E3	P401B..F4	R104.....A4	R415.....D5	R604.....A2	R884.....E3	ZD804..E1
C243.....D5	C520.....B5	C684.....C2	C804.....G2	D801.....G2	IC806..E1	P401C..F4	R105.....A4	R416.....E5	R605.....A3	R902.....B1	ZD851..E3
C246.....C5	C521.....B4	C685.....C2	C805.....G2	D802.....F3	JA01.....C5	P401D..F4	R107.....E5	R417.....D5	R606.....B3	R904.....A1	
C280.....D5	C522.....B5	C686.....C2	C806.....E1	D803.....F3	JA02.....C1	P801A..G1	R108.....A5	R418.....F4	R607.....A3	R905.....A2	

DIAGRAMA EN BLOQUE

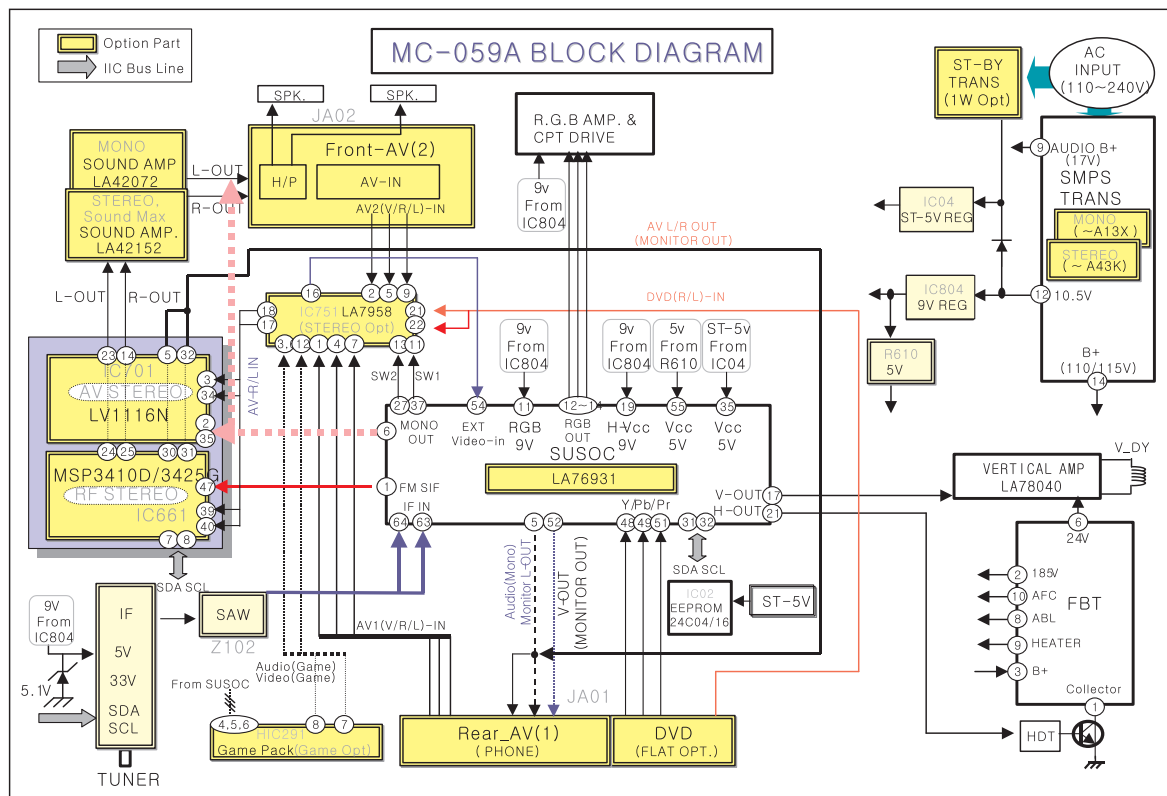

SIDE AV

